

**119** kW (Stage IIIa)**129** kW (Stage IV)**33** t**38** m**MULTICAB****633E**

Crawler telescopic crane

Stage IV

633E Advanced. The E-Series.



1978: TX10 telescopic crane

What makes up the E-Series

- Over 25 years of experience in construction and building of highly specialized telescopic cranes
- Uncompromisingly high performance in all areas
- Technology that can be mastered: High-quality components without over-engineering
- Long service life and high value stability

Your top benefits:

1

Green Efficiency

Save fuel – reduce operating costs
Work quietly – protect operator and environment



2

Peak performance

Robust boom system – work on an incline of up to 4°

3

Maximum usability

Multicab – work in comfort
SENCON – work program selection made easy



4

Flexibility in service

Operate under full load – less space required
Strong undercarriage traction – good off-road capability

5

Easy transport

Mobile undercarriage with outrigger – ready to go in no time

6

Maintenance and service made easy

SENNEBOGEN control system – easy error diagnostics
Simple maintenance – clear labeling

7

Consultation and support in your area

3 production sites – 2 subsidiaries
130 sales partners – over 350 service stations

Emissions Stage IV

- Most modern,
powerful engine
- Fuel efficient
- Clean emissions



633E Technical data, equipment

MACHINE TYPE

Model (type) **633**

ENGINE

Model Cummins diesel engine QSB 4.5
119 kW / 162 PS at 2200 min⁻¹
 Emissions according to emissions Stage IIIa

Cummins diesel engine QSB 4.5
129 kW / 175 PS at 2200 min⁻¹
 Emissions according to emissions Stage IV

Direct injection, turbo-charged, charge air cooling, reduced emissions

Cooling Water-cooled

Diesel filter With water separator and heating system

Air filter Dry filter with integrated pre-separator, automatic dust discharge, main element and safety element, contamination indicator

Fuel tank **360 l**

DEF tank **38 l**

Electr. system **24 V**

Batteries **2 x 155 AH** battery disconnect switch

Options

- Low-temperature package with engine pre-heating and heated diesel filter for temperatures below -20 °C
- Electric fuel pump

UPPERCARRIAGE

Design Torsion-resistant box design, precision crafted, steel bushings for boom bearings. Extremely service-friendly design, longitudinal engine

Electrical system Central electrical distributor, battery disconnect switch

Cooling system 3-circuit cooling system with high cooling capacity, electronically regulated fan drive for water, charge air and oil cooler

Safety Rearview and right sideview cameras, LED lighting package

Options

- Additional LED headlights
- Up to 2 additional cameras
- Maritime climate varnish as corrosion protection
- Low-temperature package for use at temperatures below -20 °C

Options

- Automatic central lubrication for boom pivot point, luffing cylinder, slewing ring track and winch drum bearing
- Pinion tooth lubrication for slewing ring

HYDRAULIC SYSTEM

Load sensing / LUDV hydraulic system, electro-hydraulic servo-assisted working functions

Pump type Swashplate-type variable-displacement piston pump, load pressure-independent flow distribution for simultaneous, independent control of work functions

Pump control Zero-stroke control, on-demand flow control – the pumps only pump as much oil as will actually be used, pressure purging, load limit sensing control

Operating pressure **max. 330 bar**

Filtration High-performance filtration with long change interval

Hydraulic tank **500 l**

Control system Proportional, precision electrohydraulic actuation of work movements, 2 electric servo joysticks for work functions, including winch motion display via vibration transducer, additional functions via switches and pedals

Safety Hydraulic circuits secured with safety valves
 Pipe fracture safety valve for luffing and telescoping cylinders

Options

- Bio-oil
- SENNEBOGEN HydroClean 3-µm hydraulic microfilter
- Electric heater for hydraulic tank for temperatures below -20 °C

SLEWING DRIVE

Gearbox Compact planetary gear with slant-axis hydraulic motor, integrated brake valves

Slewing gear Spring-loaded disk brake, pedal for individual braking

Slewing ring Externally geared slewing ring, sealed

Slewing speed **0 – 2 rpm, variable**

633E Technical data, equipment

CAB **MULTICAB**

Cab type	Multicab, can be inclined by 15°
Cab equipment	Elastically supported comfortable cab with super sound insulation. All-weather design, all-round glazing in safety glass and large roof window, adjustable windshield. Flexibly mounted comfortable seat, adjustable according to weight and shock absorbent. Dashboard overview with swiveling steering column. Variable, controllable cab heating with air circulation stage and particle filter, automatic climate control
Options	<ul style="list-style-type: none"> ■ Auxiliary heating system with timer ■ Cabs activated carbon filter ■ Armored-glass windshield ■ Armored-glass sunroof ■ Protective roof grating ■ FOPS protective roof grating ■ Radio with USB and SD connection, MP3 and Bluetooth function

EQUIPMENT

Design	Decades of experience, state-of-the-art computer simulation, maximum stability, longest service life, oversized, low-maintenance bearing points, sealed special bearing bushes, precision-crafted
Telescopic boom	3-part with pulley head, hydraulic continuously telescopic to 10-25.2 m
Hoisting winch	Drive using inclined axis hydraulic motor with compact planetary gear, traction 35 kN (40 kN in the 1st position), rope speed 0 - 95 m/min., rope diameter 14 mm, 130 m rope length.
Safety brake	Spring-loaded disk brake
Crane safety	Next-generation load moment monitoring, straightforward panel displaying all important data through SENCON display, lifting limit switch, cable exit protection, pressure relief valves and pipe fracture safety device with Eventrecorder
Cylinders	Hydraulic cylinders with high-quality sealing and guide elements
Options	<ul style="list-style-type: none"> ■ 6.5-m fly boom, tiltable (0°, 40°), extremely fast and easy setup without auxiliary devices, locked on basic boom when not in use ■ Fly boom extension to 13 m, tiltable (0°, 40°)

Options	<ul style="list-style-type: none"> ■ Wind movement display using vibrating joystick ■ Auxiliary jib, 3.5-t load capacity, 1-strand ■ 2nd crane winch: traction 35 kN (4th position), rope speed 0 - 95 m/min, rope diameter 14 mm, 130 m rope length ■ Additional load charts accepted for 2°/4° incline position ■ 7.5-kW electrohydraulic emergency unit ■ Remote radio control
---------	---

UNDERCARRIAGE

Design	T31/380 crawler undercarriage with hydraulically extendable track width. Stable welded construction.
Drive	Hydraulic travel drive per chassis side, adjustable hydraulic drive motors
Parking brake	Spring-loaded, hydraulically ventilated disk brake
Traveling gear	700 mm, 3-grouser, base plates, maintenance-free tractor drive
Speed	0 - 2.9 km/h
Options	Available crawler shoe types: <ul style="list-style-type: none"> ■ 800-mm 3-grouser crawler shoes ■ 900-mm 3-grouser base plates ■ 700 mm flat base plates

OPERATING WEIGHT

Mass	approx. 33,000 kg with telescopic boom 25.2 m, fly boom 13 m, 35 t hook, 3-grouser base plates 700 mm, 2 hoisting winch, with hydraulic telescopic undercarriage, Ballast 5 t
Notice	Service weight varies according to design.

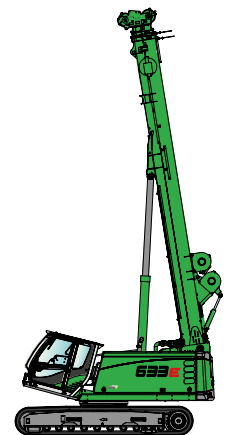

633E Crane equipment



25.2-m main boom (HA)

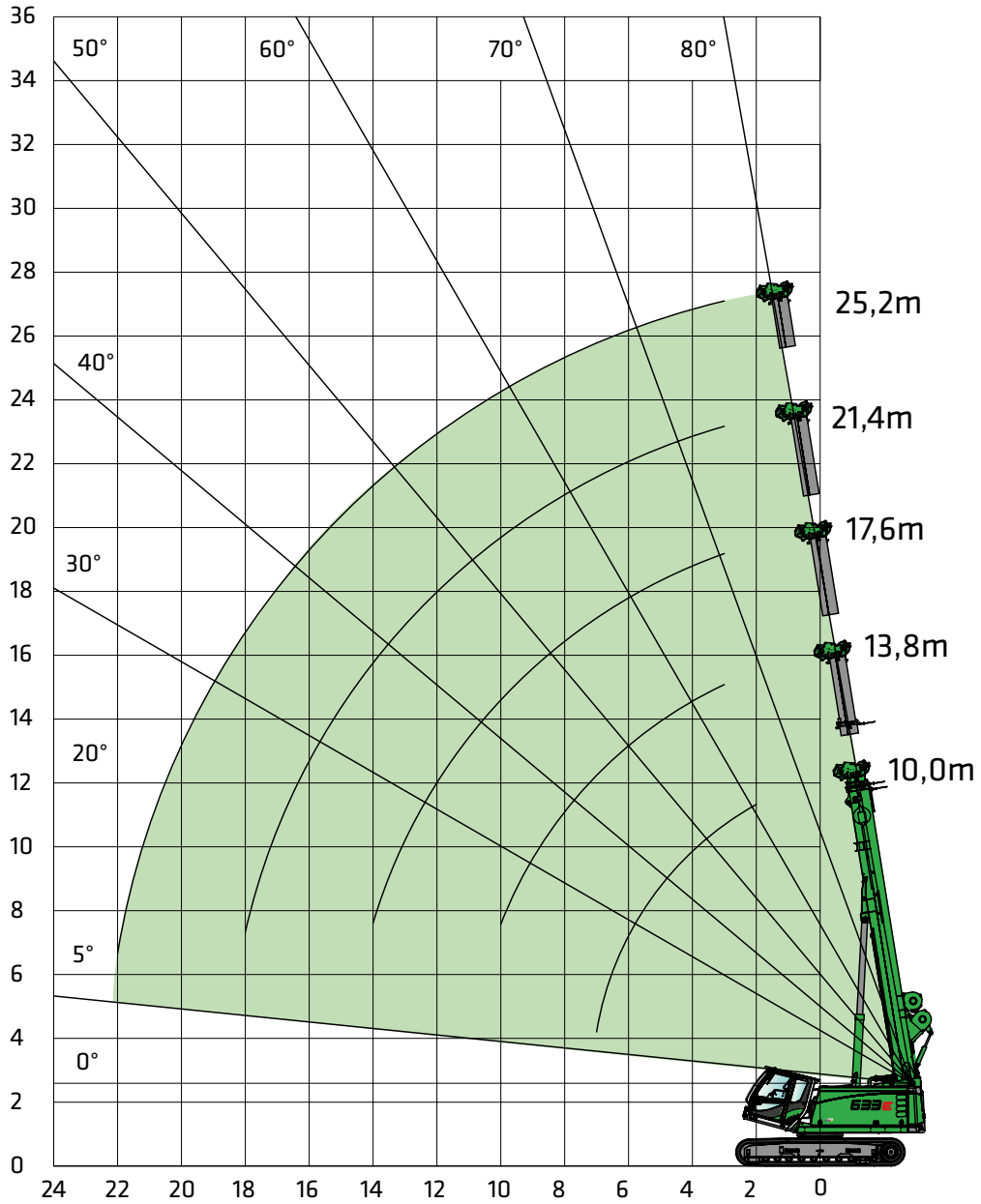

Hook

Capacity	Weight	Cable reeving and max. load capacity										
		10	9	8	7	6	5	4	3	2	1	
4 t	80 kg											3,500 kg
10.5 t 1-pulley	100 kg								10,500 kg	7,000 kg		3,500 kg
25 t 3-pulley	220 kg				24,500 kg	21,000 kg	17,500 kg	14,000 kg	10,500 kg	7,000 kg		3,500 kg
35 t 5-pulley	400 kg	33,000 kg	31,500 kg	28,000 kg	24,500 kg	21,000 kg	17,500 kg	14,000 kg	10,500 kg	7,000 kg		3,500 kg

633E Load ratings



25.2-m main boom (HA)

	Boom length [m]														
	10.0			13.8			17.6			21.4			25.2		
Counterweight [t]	5.0	5.0	5.0	5.0	5.0	5.0	5.0	5.0	5.0	5.0	5.0	5.0	5.0	5.0	5.0
Undercarriage track width [m]	3.8	3.05	2.3	3.8	3.05	2.3	3.8	3.05	2.3	3.8	3.05	2.3	3.8	3.05	2.3
Outreach [m]															
2.5	30.0	22.0	21.0												
3.0	28.5	20.0	20.0	19.0	16.0	16.0	19.0	17.0	17.0	14.2	14.2	14.2	10.3	10.3	10.3
4.0	24.5	17.0	13.0	19.0	15.0	13.0	18.3	14.0	12.0	13.2	13.2	11.2	9.8	9.8	9.8
5.0	18.8	13.0	9.5	18.5	13.5	9.7	16.9	12.0	9.1	12.0	11.3	8.2	9.3	9.3	8.2
6.0	13.6	10.0	7.1	14.0	10.3	7.4	13.6	9.6	7.3	10.8	9.1	7.1	8.6	8.6	6.8
7.0	10.5	7.7	5.6	10.8	8.0	5.9	11.0	7.7	6.0	10.0	7.6	5.9	7.9	7.2	5.9
8.0				8.7	6.4	4.7	8.8	6.4	4.9	8.9	6.3	4.9	7.3	6.2	4.7
9.0				7.2	5.3	3.9	7.4	5.3	4.0	7.4	5.4	4.2	6.8	5.4	4.1
10.0				6.0	4.5	3.3	6.2	1.5	3.5	6.3	4.5	3.5	6.4	4.6	3.5
11.0							5.3	3.8	2.9	5.4	3.9	2.9	5.5	4.0	3.0
12.0							4.5	3.3	2.5	4.7	3.4	2.6	4.7	3.5	2.7
13.0							4.0	2.8	2.1	4.1	2.9	2.1	4.1	3.0	2.2
14.0							3.5	2.5	1.8	3.6	2.6	1.9	3.6	2.7	1.9
15.0										3.2	2.3	1.6	3.2	2.3	1.7
16.0										2.8	2.0	1.3	2.8	2.0	1.4
17.0										2.5	1.7	1.1	2.6	1.8	1.2
18.0										2.2	1.5	0.9	2.3	1.5	1.0
19.0													2.0	1.3	0.8
20.0													1.8	1.1	0.6
21.0													1.6	0.9	
22.0													1.4	0.8	
23.0															
24.0															
25.0	Tab. no.: 633R-75/1977/5.0+0.0/04.17 HA 0.3*														
26.0	Tab. no.: 633R-75/1602/5.0+0.0/04.17 HA 0.3*														
Number of strands	10	10	10	8	8	8	8	8	8	6	6	6	4	4	4
I	0%			25%			50%			75%			100%		
II	0%			25%			50%			75%			100%		
Load capacity reduction [kg]	-			-			-			-			-		

633E Crane equipment



6.5-m or 13-m fly boom (SA)

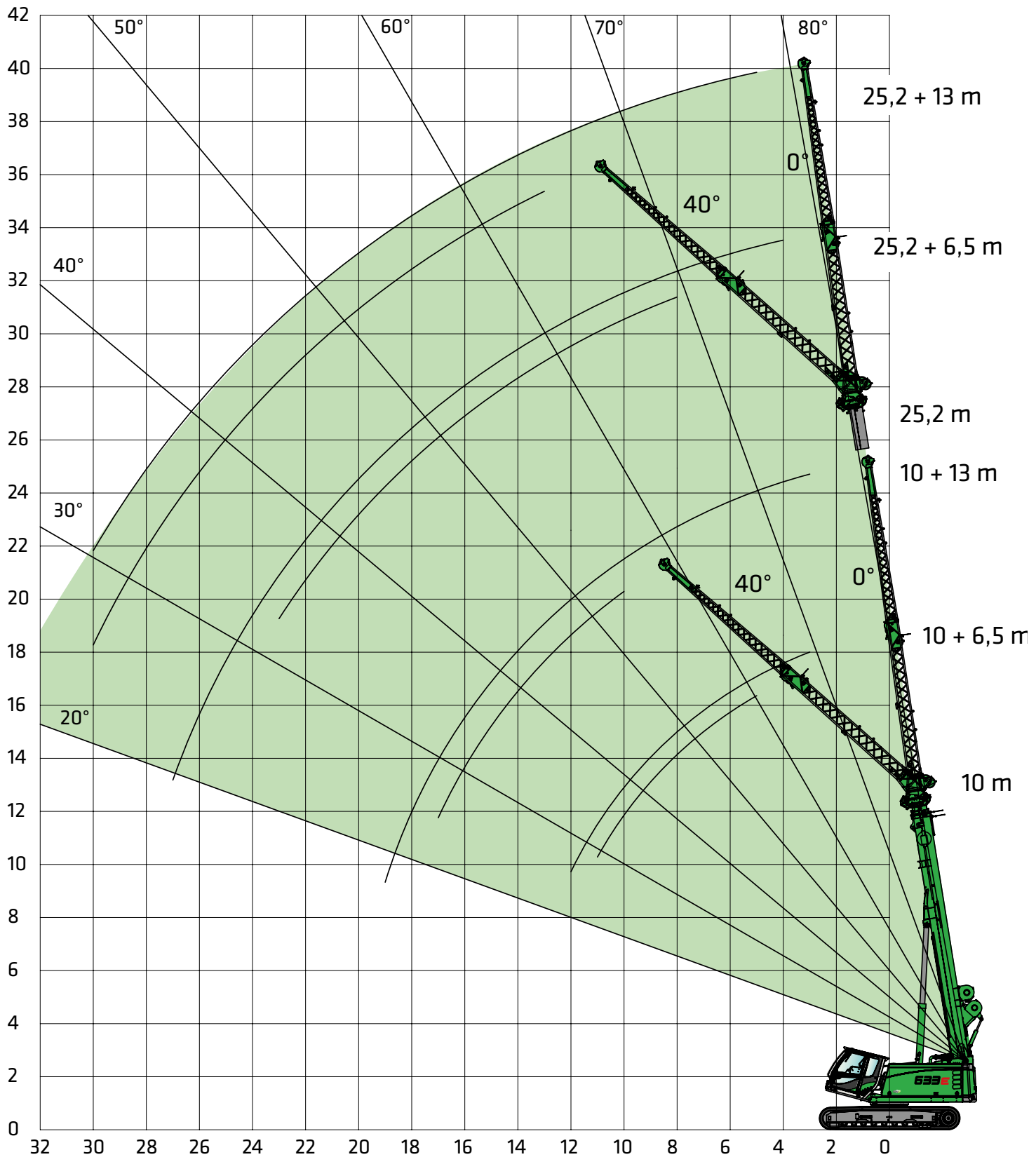

633E Load ratings



6.5-m fly boom (SA)

5.0 t	Telescopic boom length [m]									
	10.0		13.8		17.6		21.4		25.2	
3.8 m	0°	40°	0°	40°	0°	40°	0°	40°	0°	40°
Outreach [m]										
2.0										
3.0	7.0		7.0		7.0		7.0			
4.0	7.0		7.0		7.0		7.0		5.7	
5.0	6.9	4.4	7.0	4.3	7.0		6.9		5.7	
6.0	6.7	4.1	6.9	4.2	7.0	4.2	6.7		5.5	
7.0	6.1	3.9	6.8	4.1	6.9	4.1	6.5	4.0	5.4	
8.0	5.5	3.8	6.4	3.9	6.7	4.0	6.2	3.9	5.1	3.8
9.0	5.1	3.6	6.0	3.8	6.4	3.9	5.8	3.8	4.9	3.7
10.0	4.7	3.6	5.5	3.7	6.0	3.8	5.5	3.7	4.7	3.6
11.0	4.3	3.5	5.2	3.6	5.5	3.7	5.3	3.6	4.4	3.6
12.0	3.9		4.8	3.5	4.8	3.6	4.8	3.5	4.2	3.5
13.0			4.2	3.4	4.2	3.5	4.1	3.5	3.9	3.4
14.0			3.7	3.3	3.7	3.4	3.6	3.4	3.7	3.4
15.0			3.3		3.2	3.3	3.2	3.4	3.1	3.3
16.0			2.9		2.8	3.1	2.8	3.2	2.8	3.2
17.0					2.5	2.8	2.5	2.8	2.5	2.8
18.0					2.3		2.2	2.5	2.3	2.6
19.0					2.0		1.9	2.2	2.0	2.3
20.0							1.7	1.9	1.7	2.1
21.0							1.5		1.5	1.8
22.0							1.4		1.3	1.6
23.0							1.1		1.2	1.4
24.0									1.0	
25.0									0.8	
26.0									0.7	
27.0									0.6	
28.0										
29.0										
30.0										
31.0										
32.0										
33.0										
34.0	633R-75/1977/5.0+0.0/04.17 SA6.5									
Number of strands	2	2	2	2	2	2	2	2	2	2
I	0%		25%		50%		75%		100%	
II	0%		25%		50%		75%		100%	

633E Load ratings



13-m fly boom (SA)

5.0 t	Telescopic boom length [m]									
	10.0		13.8		17.6		21.4		25.2	
3.8 m	0°	40°	0°	40°	0°	40°	0°	40°	0°	40°
Outreach [m]										
2.0										
3.0	3.5		3.5		3.5					
4.0	3.5		3.5		3.5		3.2			
5.0	3.5		3.5		3.5		3.2		2.4	
6.0	3.5		3.5		3.5		3.2		2.4	
7.0	3.3		3.4		3.4		3.2		2.4	
8.0	3.1		3.3		3.3		3.1		2.4	
9.0	2.8		3.1		3.1		3.0		2.4	
10.0	2.6	1.7	2.9	1.7	3.0		2.8		2.4	
11.0	2.5	1.6	2.7	1.7	2.8	1.7	2.7		2.4	
12.0	2.3	1.6	2.5	1.7	2.7	1.7	2.6	1.6	2.4	
13.0	2.1	1.5	2.4	1.6	2.6	1.6	2.5	1.6	2.4	1.5
14.0	2.0	1.5	2.3	1.6	2.4	1.6	2.4	1.5	2.4	1.5
15.0	1.9	1.4	2.1	1.5	2.3	1.5	2.3	1.5	2.2	1.4
16.0	1.8	1.4	2.0	1.5	2.2	1.5	2.2	1.4	2.1	1.4
17.0	1.7	1.3	1.9	1.4	2.1	1.5	2.1	1.4	2.0	1.4
18.0	1.6		1.8	1.4	2.0	1.4	2.0	1.4	2.0	1.4
19.0	1.5		1.7	1.4	1.9	1.4	1.9	1.3	1.9	1.3
20.0			1.6	1.4	1.8	1.4	1.9	1.3	1.8	1.3
21.0			1.5		1.7	1.4	1.8	1.3	1.8	1.3
22.0			1.4		1.7	1.3	1.6	1.3	1.6	1.3
23.0					1.5	1.3	1.5	1.3	1.4	1.3
24.0					1.4		1.3	1.3	1.2	1.2
25.0					1.3		1.1	1.3	1.1	1.2
26.0							1.0	1.2	0.9	1.2
27.0							0.9		0.8	1.1
28.0							0.8		0.7	1.0
29.0									0.6	0.9
30.0									0.6	0.8
31.0										
32.0										
33.0										
34.0	633R-75/1977/5.0+0.0/04.17 SA13									
Number of strands	2	1	2	1	2	1	2	1	2	1
I	0%		25%		50%		75%		100%	
II	0%		25%		50%		75%		100%	

633E Load ratings



Auxiliary jib (HA-S)

	Boom length [m]														
	10.0			13.8			17.6			21.4			25.2		
Counterweight [t]	5.0	5.0	5.0	5.0	5.0	5.0	5.0	5.0	5.0	5.0	5.0	5.0	5.0	5.0	5.0
Undercarriage track width [m]	3.8	3.05	2.3	3.8	3.05	2.3	3.8	3.05	2.3	3.8	3.05	2.3	3.8	3.05	2.3
Outreach [m]															
2.0	3.5	3.5	3.5												
3.0	3.5	3.5	3.5	3.5	3.5	3.5	3.5	3.5	3.5	3.5	3.5	3.5	3.5	3.5	3.5
4.0	3.5	3.5	3.5	3.5	3.5	3.5	3.5	3.5	3.5	3.5	3.5	3.5	3.5	3.5	3.5
5.0	3.5	3.5	3.5	3.5	3.5	3.5	3.5	3.5	3.5	3.5	3.5	3.5	3.5	3.5	3.5
6.0	3.5	3.5	3.5	3.5	3.5	3.5	3.5	3.5	3.5	3.5	3.5	3.5	3.5	3.5	3.5
7.0	3.5	3.5	3.5	3.5	3.5	3.5	3.5	3.5	3.5	3.5	3.5	3.5	3.5	3.5	3.5
8.0				3.5	3.5	3.5	3.5	3.5	3.5	3.5	3.5	3.5	3.5	3.5	3.5
9.0				3.5	3.5	3.5	3.5	3.5	3.5	3.5	3.5	3.5	3.5	3.5	3.5
10.0				3.5	3.5	3.2	3.5	3.5	3.4	3.5	3.5	3.4	3.5	3.5	3.4
11.0							3.5	3.5	2.8	3.5	3.5	2.8	3.5	3.5	2.9
12.0							3.5	3.2	2.4	3.5	3.3	2.5	3.5	3.4	2.6
13.0							3.5	2.7	2.0	3.5	2.8	2.0	3.5	2.9	2.1
14.0							3.4	2.4	1.7	3.5	2.5	1.8	3.5	2.6	1.8
15.0										3.1	2.2	1.5	3.1	2.2	1.6
16.0										2.7	1.9	1.2	2.7	1.9	1.3
17.0										2.4	1.6	1.0	2.5	1.7	1.1
18.0										2.1	1.4	0.8	2.2	1.4	0.9
19.0													1.9	1.2	0.7
20.0													1.7	1.0	0.5
21.0													1.5	0.8	
22.0													1.3	0.7	
23.0															
24.0															
25.0	Tab.no.: 633R-75/1977/5.0+0.0/04.17 HA-S 0.3°														
26.0	Tab.no.: 633R-75/1602/5.0+0.0/04.17 HA-S 0.3°														
26.0	Tab.no.: 633R-75/1227/5.0+0.0/04.17 HA-S 0.3°														
Number of strands	10	10	10	8	8	8	8	8	8	6	6	6	4	4	4
I	0%			25%			50%			75%			100%		
II	0%			25%			50%			75%			100%		
Load capacity reduction [kg]	-			-			-			-			-		

633E Load capacity programs

	Main boom HA			Auxiliary jib HA-S			Fly boom SA 6.5 m			Fly boom SA 13 m		
Counterweight [t]												
Undercarriage track width	3.8 m	3.0 m	2.3 m	3.8 m	3.0 m	2.3 m	3.8 m	3.0 m	2.3 m	3.8 m	3.0 m	2.3 m
5.0 t	360°	360°	360°	360°	360°	360°	360°	-	-	360°	-	-

Note:

Optional load capacities available for 2° and 4° incline positions.

1. Specified load ratings only apply when machine is level ($\pm 0.3^\circ$) and stable.
2. The safe working load values are specified in tons (t) and apply for 360 degrees.
3. Load ratings are in accordance with EN 13000.
4. The weight of the load handling devices (e.g., hook, cable) must be subtracted from the load ratings.
5. Load ratings must be limited or reduced when conditions are unfavorable, such as soft or uneven ground, slopes, wind, lateral loads, swinging loads, jerking or sudden stopping of load, operator inexperience, driving with load.
6. Permissible cable pull per strand in crane mode for cable diameter 14 mm – 3,500 kg.
7. Specified load ratings are for reference only. See the tables in the operating manual for the applicable load rating.
8. Optional load capacities available for 2° and 4° incline positions.

633E Fly boom

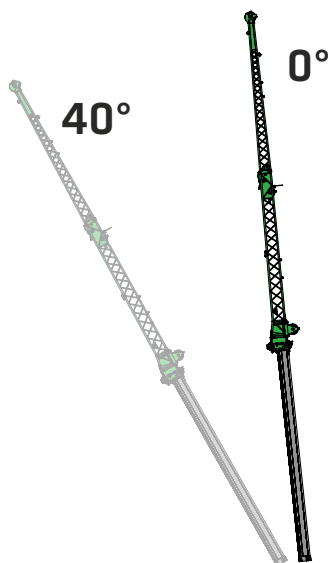

Fly boom variants

- 6.5 m fly boom
Max. 2-strand, possible offset angle 0°/40°
- 13 m fly boom
with 6.5 m extension,
1-strand, offset angle 0°/40°
- Auxiliary jib
3.5 t load capacity, 1-strand

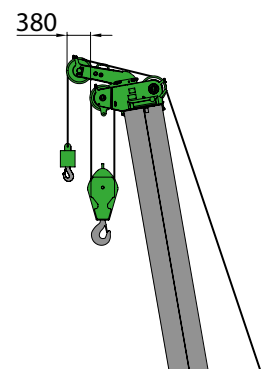

633E Transport dimensions and weights

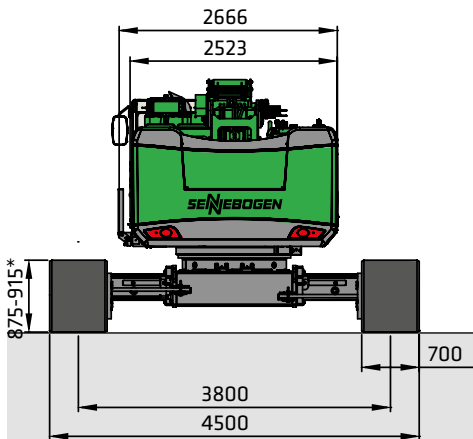

Base plates	Min. transport width
700 mm	3000 mm
800 mm	3300 mm
900 mm	3400 mm

633 with undercarriage T31/380 and 700 mm 3-grouser base plates
 Service weight: approx. 33,000 kg
 (with 13 m fly boom, 2 hoisting winches, counterweight 5 t as well as hook 35 t)

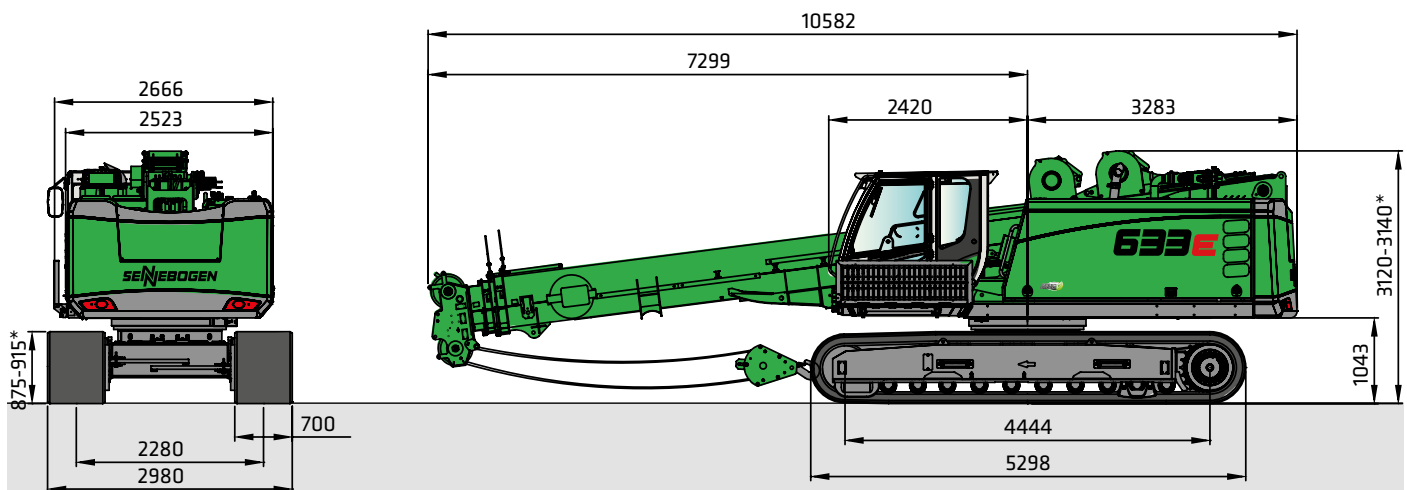

Transport weight: approx. 33,000 kg
 (with 13 m fly boom, 2 hoisting winches, counterweight 5 t as well as hook 35 t)

633E Transport dimensions and weights

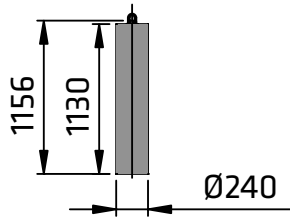

Insert weights

2x 400 kg

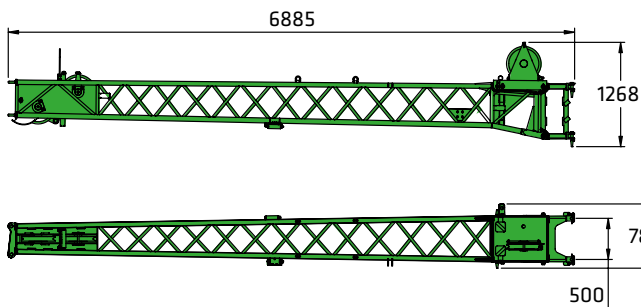

6.5-m fly boom

600 kg

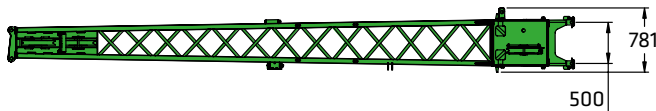

6.5-m fly boom extension

250 kg

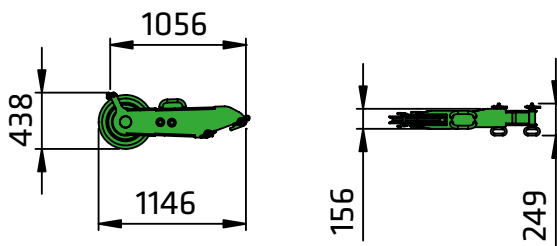
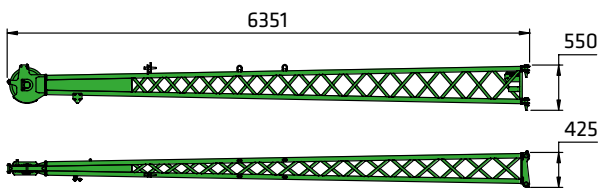

Auxiliary jib

50 kg

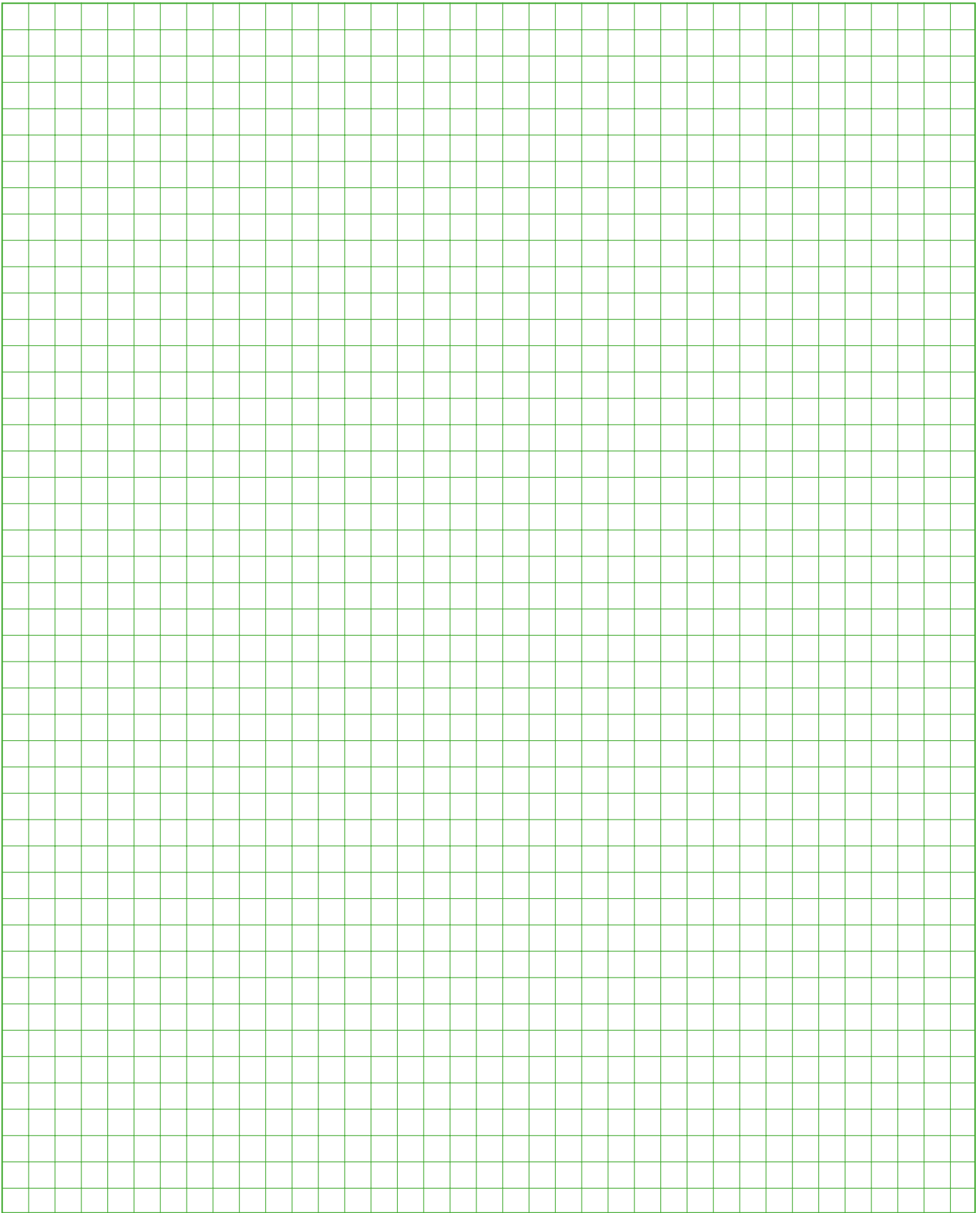

633E

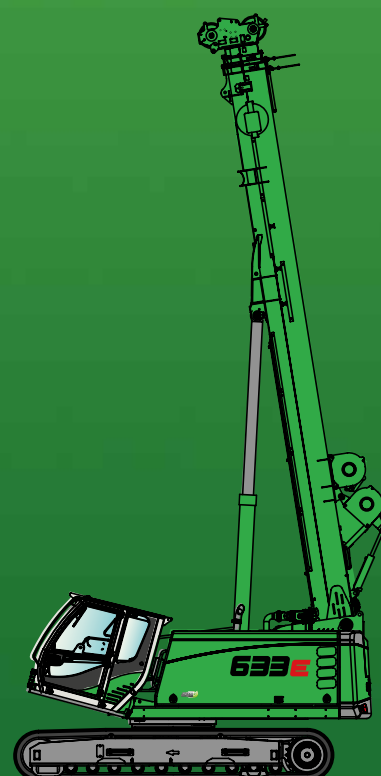

This catalog describes machine models, scopes of equipment of individual models, and configuration options (standard equipment and optional equipment) of the machines delivered by SENNEBOGEN Maschinenfabrik. Machine illustrations can contain optional equipment and supplemental equipment. Actual equipment may vary in a tolerance range depending on the country to which the machines are delivered, especially in regard to standard and optional equipment

All product designations used may be trademarks of SENNEBOGEN Maschinenfabrik GmbH or other supplying companies, and any use by third parties for their own purposes may violate the rights of the owners.

Please contact your local SENNEBOGEN sales partner for information concerning the equipment variants offered. Requested performance characteristics are only binding if they are expressly stipulated upon conclusion of the contract. Delivery options and technical features are subject to change. Errors and omissions excepted. Equipment is subject to change, and rights of advancement are reserved.

© SENNEBOGEN Maschinenfabrik GmbH, Straubing/Germany. Reproduction in whole or in part only with written consent of SENNEBOGEN Maschinenfabrik GmbH, Straubing, Germany.

 06 03 00 44 76
 atmlevage@groupeatm.com
 www.atmlevage.com

ATM-LEVAGE
Location de grues & mini grues