

ATM-LEVAGE

Location de grues & mini grues

JMG MC 25S



☎ 06 03 00 44 76

✉ atmlevage@groupeatm.com

🌐 www.atmlevage.com

SEQUENTIAL TELESCOPING BOOM

FRONT-WHEELS DRIVE WITH COUNTER ROTATION

TILTING HEAD 4 POSITIONS (-70°/-35°/0°/+10°)

REMOVABLE COUNTERWEIGHT

USB PLUG







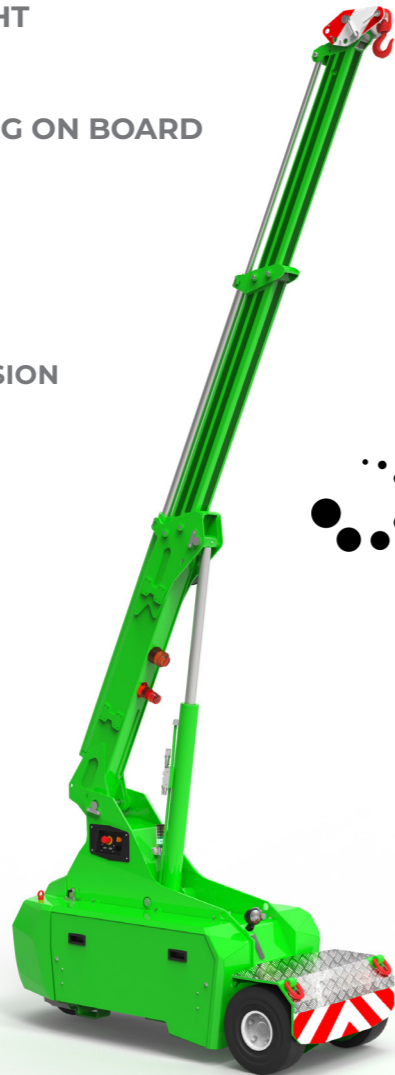

BLOCKS AND HOOKS LODGING ON BOARD

Optionals:

- HYDRAULIC WINCH
- BENDABLE MANUAL EXTENSION
- NON-MARKING TIRES
- MAN BUCKET
-  ATEX CONVERSIONS
- CUSTOMIZED PAINTING
- TOOL BOX





i **Technical features**

Max Capacity kg	 2.500	 Front-wheels drive. 2 electric motors AC 2 kW 24V Insulation class H	LMI. Electronic safe load indicator and tilting moment limiter
	Dimensions mm	 2190x900x1610	 Total Kg. 2.400 Removable counterweight Kg. 750
			 24 V - 420 Ah 8 working hours
		 Front nr. 2 superelastic 18x7-8" Rear nr. 2 superelastic 15x4 1/2-8"	 +65°/-15°
		 Rear Steering angle -90°/+90°	 Motor driven pump 3 kW - 24 V AC, Insulation class H

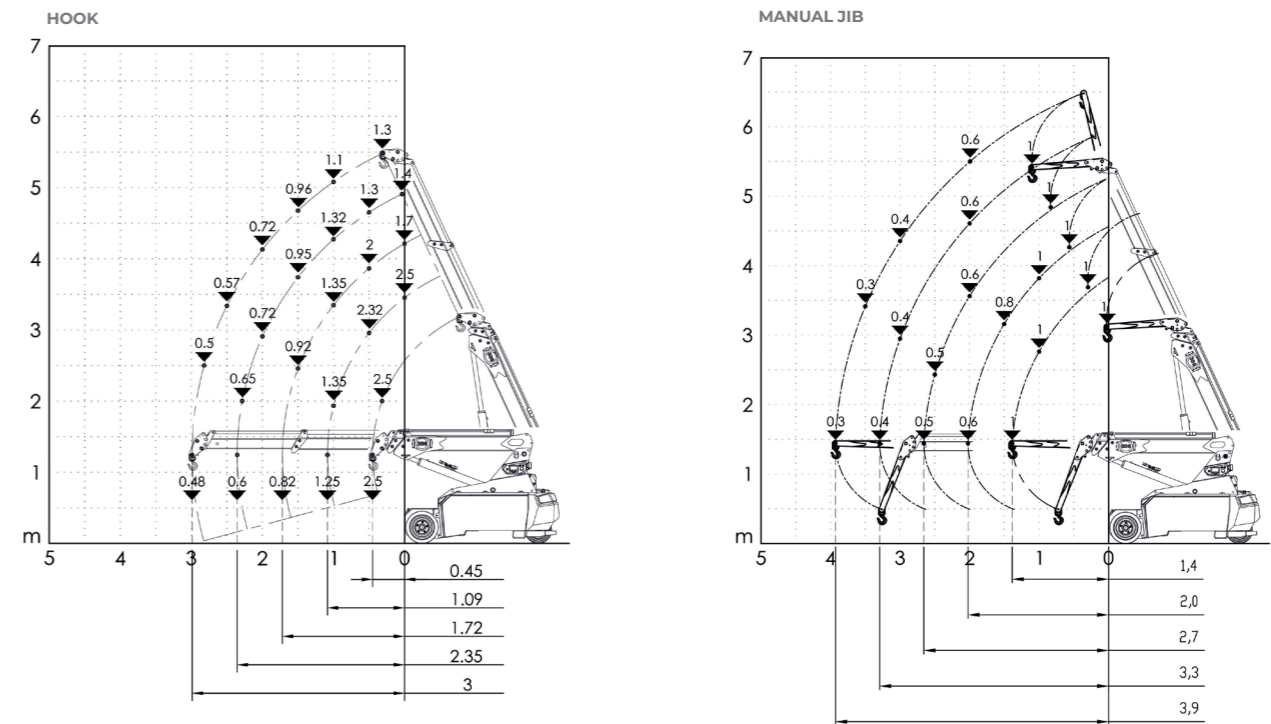
Load charts



EU Standards CE

	UNI ISO 4030-2: A1
	2006/42/CE- 2000/14/CE -2014/30 UE 2014/35/UE - D.Lgs 262/2002 subsequent modifications
	EN 13000:2014 subsequent modifications

Dimensions

